

SECTION Y-Y
SCALE 1 : 8

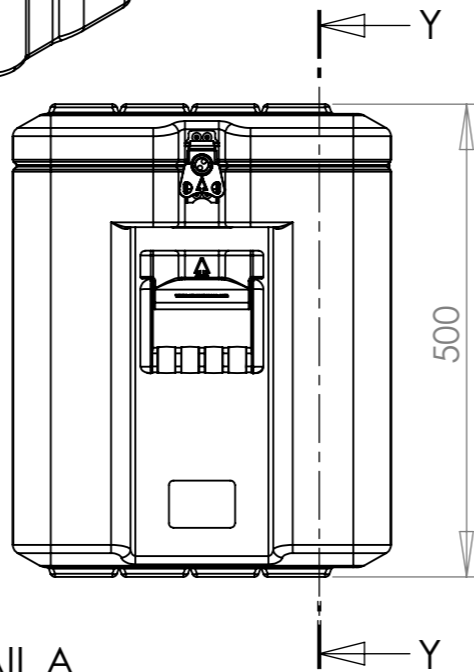

DETAIL A
SCALE 1 : 5

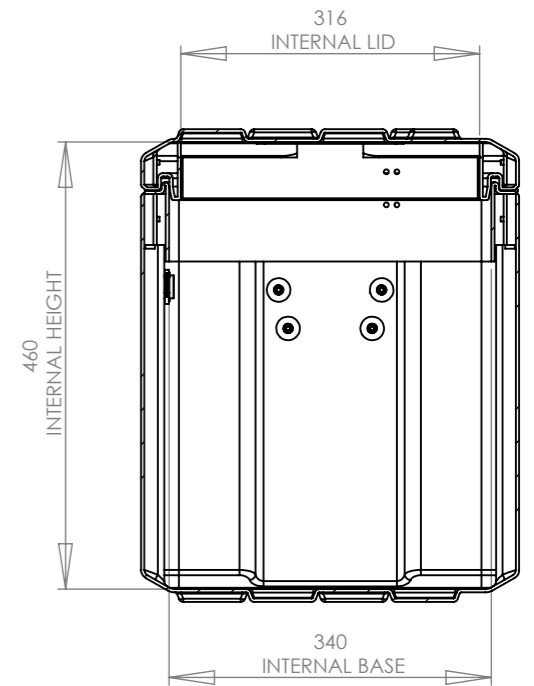
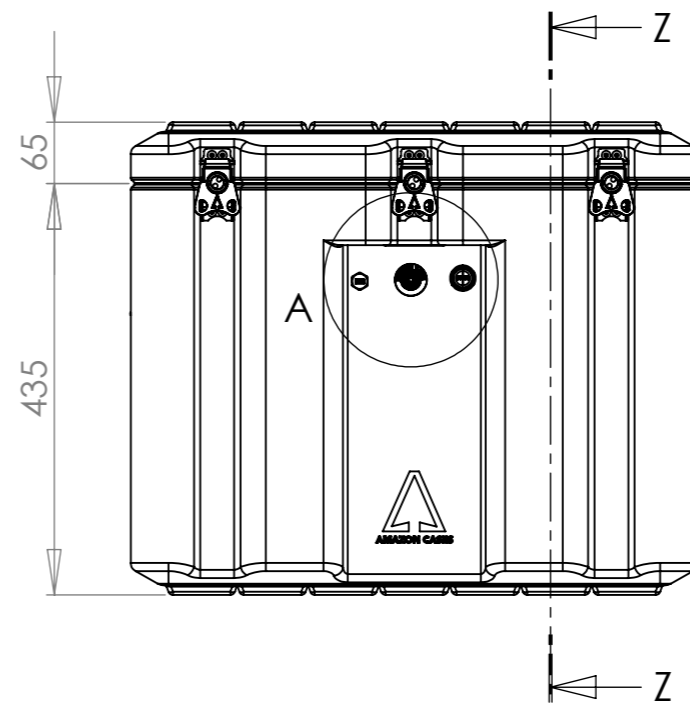

SECTION Z-Z
SCALE 1 : 8

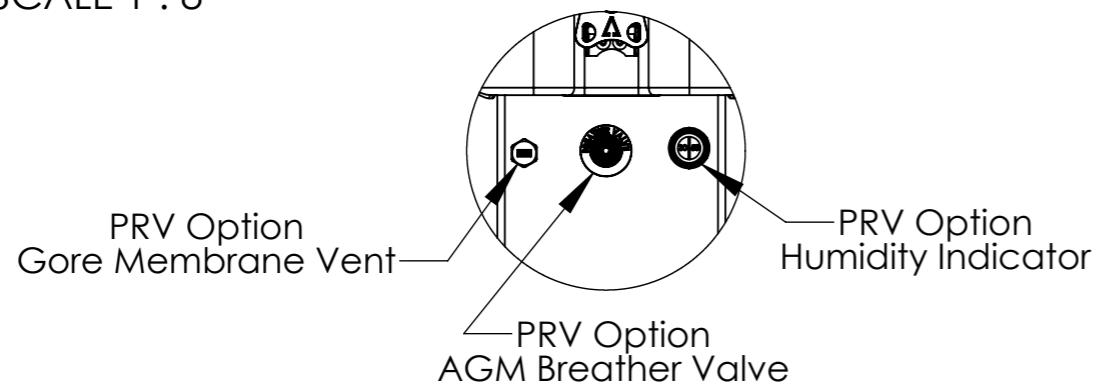
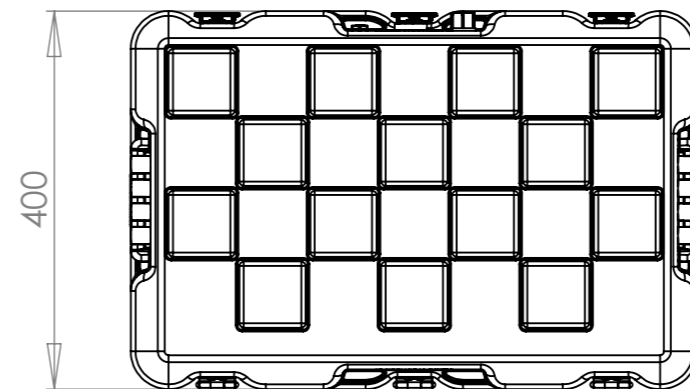

Options Available	Option Selected	Qty	Part #	Nato Stock No (NSN)			
Wheel Kit	N	00	AAW001	8145-99-551-4820			
AGM Breather Valve	Y	01	AAPRV	Moulding Tolerance +/- (1%+1mm)			
Gore Membrane Vent	Y	01	AAGTV				
Humidity Indicator	Y	01	AAHI	External Dimensions (mm)			
Tie Down Anchor	N	00	AATD001		Length	Width	Height
Padlockable Latch	N	00	AALPLBK		600	400	500
Latch	Y	05	AALBK	Internal Dimensions (mm)	Length	Width	Height
Plastic Handles	Y	02	AAHPL		540	340	460

Title			Drg. No.	
Amazon Case AC6040-4307			AC6040-4307	
Drawn By	Date	Sheet No.	Issue No.	
MW	18/06/2010	1 Of 1	1	
Dimensions In Millimeters		Third Angle Projection		
Do Not Scale				

CP Cases Ltd.

Worton Hall Industrial Estate, Worton Road,
Isleworth, Middlesex, TW7 6ER, UK.
Tel: +44 (0) 20 8568 1881 Fax: +44 (0) 20 8568 1141
Email: amazon@cpcases.com Website: www.cpcases.com

Copyright CP Cases Limited.
This drawing is the property of CP Cases Limited & the information on it is confidential & it is not to be used for any other purpose without the prior written consent of CP Cases Limited.