

NOTE:
ALL CATCH LIFT OFF LID.

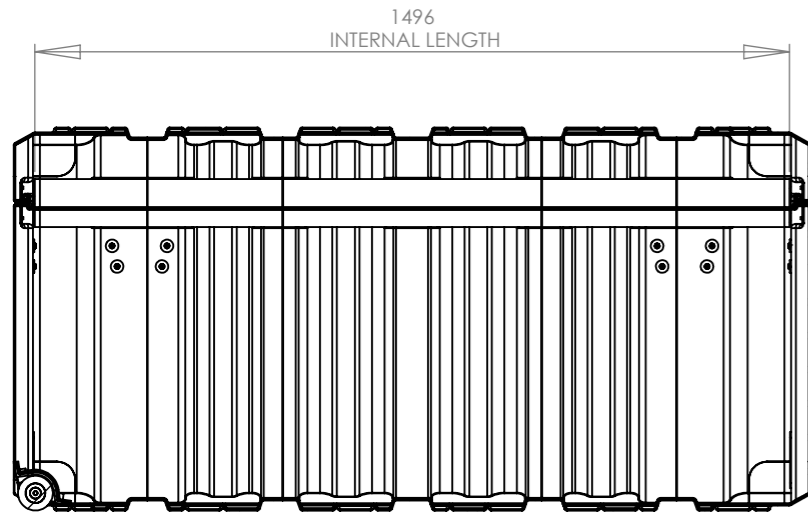

SECTION Y-Y
SCALE 1 : 15

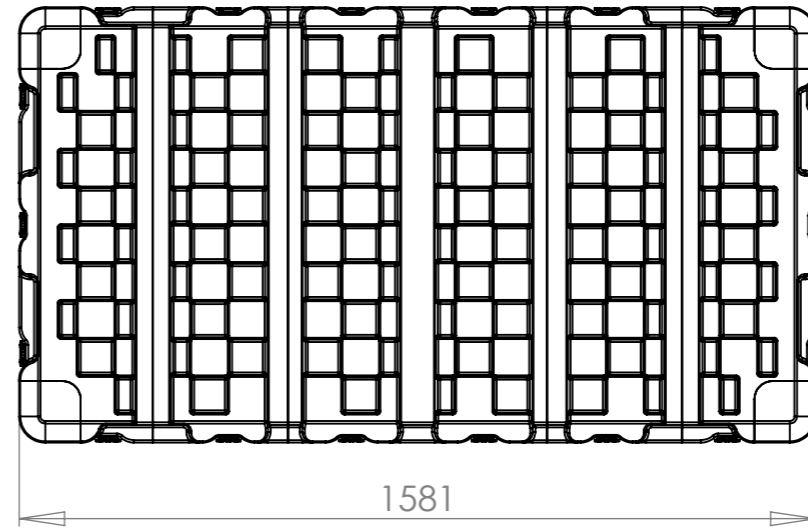
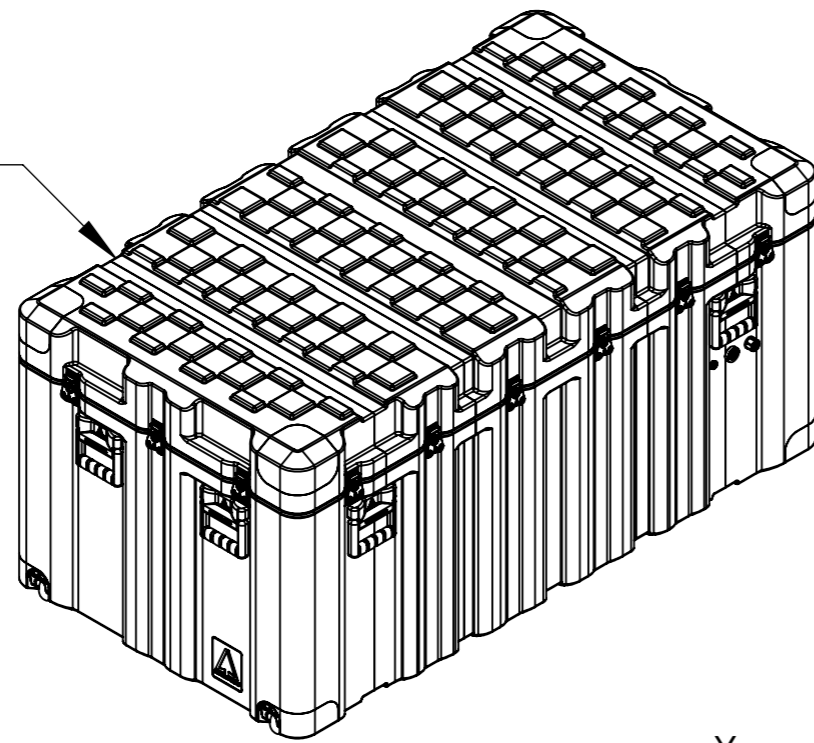
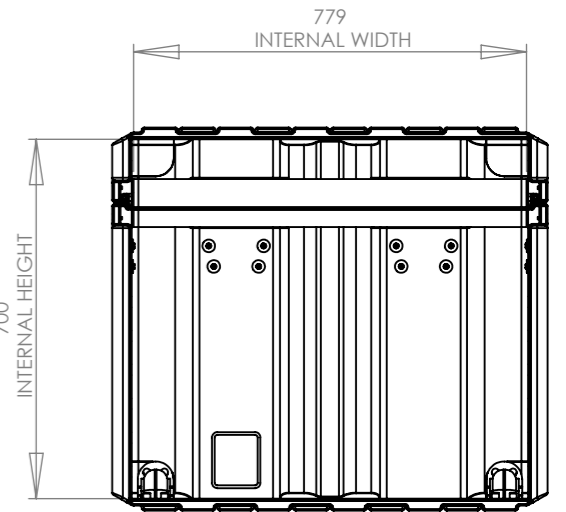
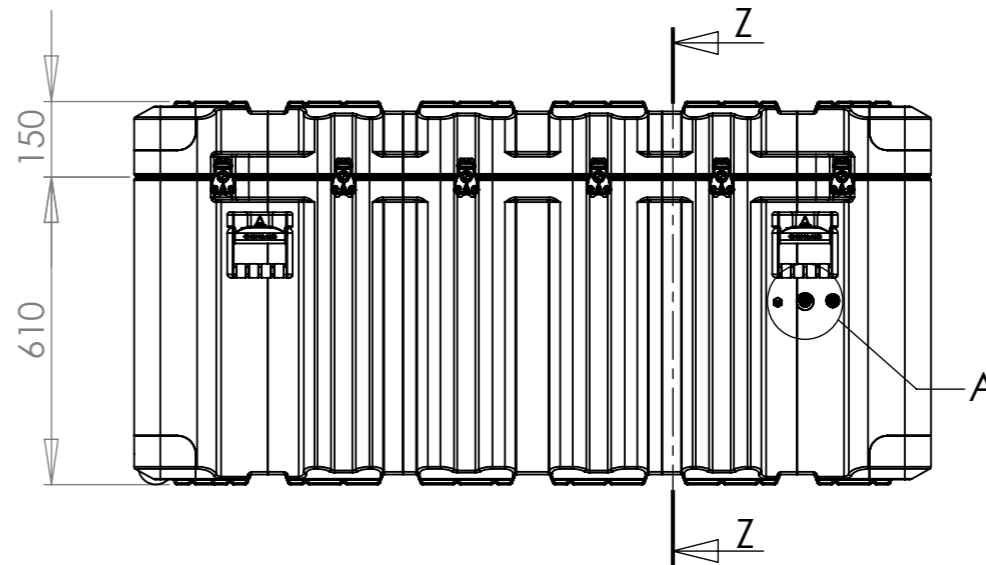
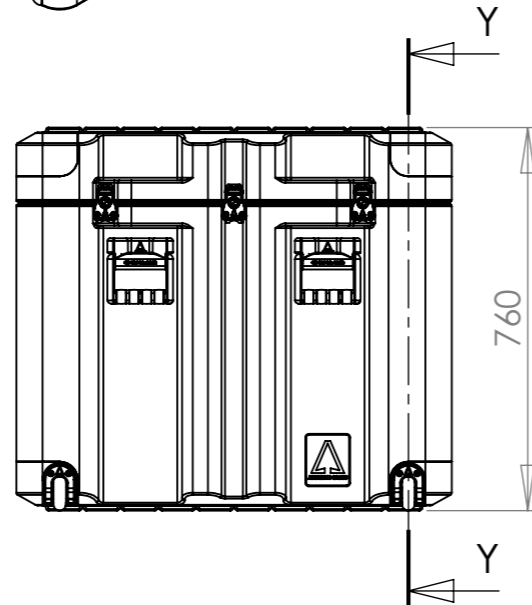

SECTION Z-Z
SCALE 1 : 15

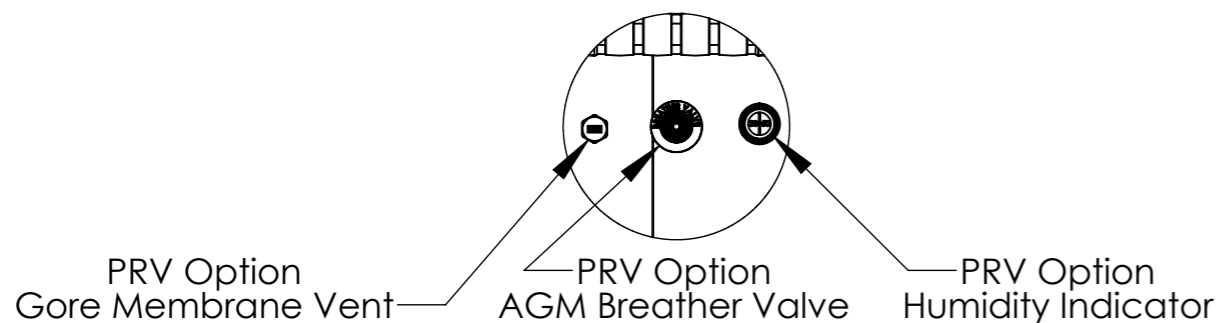

DETAIL A
SCALE 1 : 5

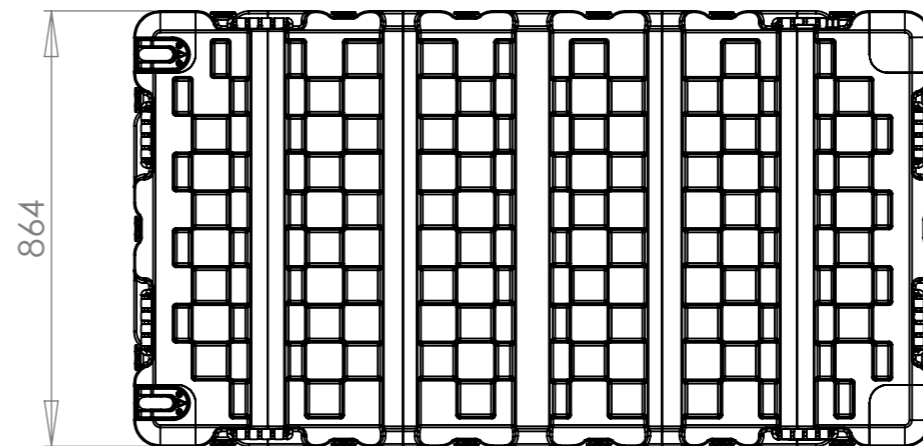

Title Amazon Case AC1687-6115/AC		Material Polyethylene		Finish Self Colour		Date 23/06/2010	Drawn By MW	Revision A	Project Amazon		CP Cases Ltd. Worton Hall Industrial Estate, Worton Road, Isleworth, Middlesex, TW7 6ER, UK. Tel: +44 (0) 20 8568 1881 Fax: +44 (0) 20 8568 1141 Email: info@cpcases.com Website: www.cpcases.com
Drg. No. AC1687-6115_AC		External Dimensions		Internal Dimensions		W/O No. 000000	Qty. 00	Sheet No. 1 Of 2	Nato Stock No. 8145-99-254-3587		
	Height	Width	Length/Depth	Height	Width	Length/Depth	Dimensions In Millimeters. Do Not Scale. Third Angle Projection.			Tolerance Unless Stated Otherwise. Moulding Tolerance +/- (1%+1mm). Sheet Metal Tolerance +/-0.5mm.	Copyright CP Cases Ltd. This drawing is the property of CP Cases Ltd & the information on it is confidential. It is not to be used for any other purpose without the prior written consent of CP Cases Ltd.
	760	864	1581	700	779	1496					